

# SOFIA 568

**HD** Radio SiteStreamer+™

## Installation & User Guide





**PRODUCT REGISTRATION RECORD**

SOFIA 568 – Serial No. \_\_\_\_\_

Purchase Date \_\_\_\_\_

Warranty Registered?  Web

Reg. Date \_\_\_\_\_ By: \_\_\_\_\_

# Installation & Operation User Guide

# SOFIA 568

 **Radio® SiteStreamer+™**

February, 2020  
Firmware Rev. 1.1.0.0  
(UDP & Admin/User Passwords)

Inovonics, Inc. 5805 Highway 9  
Felton, CA 95018  
Tel: (831) 458-0552 Fax: (831) 458-0554  
Register online at [www.inovonicsbroadcast.com](http://www.inovonicsbroadcast.com)

HD Radio Technology is manufactured under license from iBiquity Digital Corporation. U.S. and Foreign Patents apply. For patents see <http://patents.dts.com/>. HD Radio and the HD, HD Radio and "ARC" logos are registered trademarks of iBiquity Digital Corporation in the United States and/or other countries.

# TABLE OF CONTENTS

## Section I – INTRODUCTION

SOFIA 568 PRODUCT DESCRIPTION	
‘SiteStreamers’ Defined.....	6
Product Features .....	6
SOFIA 568 TECHNICAL SPECIFICATIONS	
Specifications.....	7
Block Diagram.....	8

## Section II – INSTALLATION

GENERAL	
Unpacking and Inspection.....	9
MOUNTING, POWER AND ENVIRONMENT	
Rack Requirement.....	9
Heat Dissipation.....	9
AC Mains Power.....	10
Radio Frequency Interference (RFI) .....	10
Ground Loops.....	10
INPUTS, OUTPUTS AND PORTS	
Antenna Input and Considerations .....	10
Analog Line Outputs.....	10
Unbalanced Operation .....	11
AES Digital Line Output.....	11
AoIP Streaming Port and Levels .....	11
LAN Network Port .....	11
GPOs .....	11

## Section III – SETUP AND OPERATION

PRELIMINARY INFORMATION	
Quick Boot.....	12
Front Panel vs. Web Interface Setup.....	12
THE SOFIA 568 FRONT PANEL	
The Jog-Wheel Knob.....	12
The BACK Button.....	13
Graphic Display.....	13
Local Alarms .....	13
Level Meters.....	13
Menu Timeout and Screensaver.....	13
THE FRONT-PANEL MENU TREE	
Menu Tree.....	14

GETTING UP AND RUNNING	
The Main Menu .....	15
Finding the SOFIA 568's IP Address .....	15
Assigning a Fixed IP Address .....	15
Connecting to the SOFIA 568 .....	15
NOW PLAYING	
Remote Listening .....	16
'VU' Meter .....	16
Signal Metrics.....	16
Alarms .....	17
Audio Program Metadata .....	17
Tuning and Program Selection.....	17
The Split Mode .....	18
Station Presets.....	18
StationRotation™.....	19
THE LISTENER EXPERIENCE	
Definition .....	19
Display Options.....	19
Graphics Error Reporting .....	20
Additional Image Data.....	21
GRAPHS AND METERING	
Audio Level Metering.....	21
Histograms.....	21
The BandScanner™ Utility .....	22
RDS INFO	
RDS Data Display .....	24
HD INFO	
Housekeeping .....	24
Program-Specific Information` .....	25
Image Data.....	25
ALARMS	
Alarm Status.....	26
Audio Loss .....	26
Low Signal.....	27
RDS Alarm .....	27
RT Update.....	27
Pilot Loss .....	28
HD Loss.....	28
HD PSD.....	28
HD Logo Alarm.....	28
HD Artist Experience.....	28
HD Image Issues .....	28
HD Emergency Alerts.....	28
Alarm Logging.....	29
SETUP	
Radio Settings.....	29
Audio Outputs.....	30
Streaming Outputs.....	30
General Purpose Outputs .....	31

<b>NETWORK SETUP AND INTERNET ACCESS</b>	
<b>IP Setup</b> .....	<b>31</b>
<b>Assigning a Hostname</b> .....	<b>31</b>
<b>HTTP Port</b> .....	<b>32</b>
<b>MAC Address</b> .....	<b>32</b>
<b>Link Speed</b> .....	<b>32</b>
<b>Addressing the SOFIA 568</b> .....	<b>33</b>
<b>Incoming Internet Access</b> .....	<b>33</b>
<b>DANTE® AND AoIP STREAMING</b>	
<b>IP Settings Mode</b> .....	<b>33</b>
<b>AES67 and AoIP Streaming</b> .....	<b>34</b>
<b>The AoIP MAC Address</b> .....	<b>34</b>
<b>Link Speed</b> .....	<b>34</b>
<b>Audio Format</b> .....	<b>34</b>
<b>Transmit Flows</b> .....	<b>34</b>
<b>The Dante Controller</b> .....	<b>34</b>
<b>SNMP OPERATION</b>	
<b>Overview</b> .....	<b>34</b>
<b>Mode</b> .....	<b>35</b>
<b>Security</b> .....	<b>35</b>
<b>Ports</b> .....	<b>35</b>
<b>Trap Destinations</b> .....	<b>35</b>
<b>The MIB File</b> .....	<b>35</b>
<b>EMAIL</b>	
<b>Email and Text Notifications</b> .....	<b>35</b>
<b>SMTP Setup</b> .....	<b>36</b>
<b>Recipients (Send To)</b> .....	<b>36</b>
<b>Notifications (Send What)</b> .....	<b>36</b>
<b>TIME SETUP</b>	
<b>Time and DST</b> .....	<b>37</b>
<b>Presentation Formats</b> .....	<b>37</b>
<b>RTC Battery</b> .....	<b>37</b>
<b>Time Server</b> .....	<b>37</b>
<b>ADMINISTRATIVE MATTERS</b>	
<b>Security and Passwords</b> .....	<b>37</b>
<b>Signing In</b> .....	<b>38</b>
<b>Lost Password (Hard Reset)</b> .....	<b>38</b>
<b>The Hardware Profile</b> .....	<b>39</b>
<b>Reboot</b> .....	<b>39</b>
<b>Updating Firmware</b> .....	<b>39</b>
<b>'About' Info</b> .....	<b>40</b>
<b>INOVONICS WARRANTY</b> .....	<b>(INSIDE BACK COVER)</b>

# Section I

## INTRODUCTION

### SOFIA 568 PRODUCT DESCRIPTION

**'SiteStreamers' Defined** Inovonics' SiteStreamers™ are Web-enabled, off-air radio receivers that enable broadcasters to monitor their stations from a remote location outside the station's coverage area. Using any computer or mobile device, station personnel can listen to the audio program and read associated metadata and signal metrics.

The elite SiteStreamer+™ ('plus') series includes additional features. The SOFIA 568 can display HD Radio 'Listener Experience' graphics, and provide a signal data and image history of an entire broadcast day.

**Product Features**

Leading features of the Inovonics SOFIA 568 include:

- Digital "SDR" (Software-Defined Radio) off-air reception of analog-FM and HD Radio programs HD1-HD8.
- Stays on-channel and on-mode through signal and power loss; does not auto-blend between FM and HD like a consumer radio.
- Provides analog, AES3-digital, HTTP/UDP Web-streaming and independent AoIP-streaming program audio outputs.
- Displays FM/RDS and HD/PAD data in real time; gives on-screen presentation of station logos and album art.
- Collects and displays a history of signal parameters, HD Radio album artwork, station logos, etc.
- StationRotation™ allows automatic sequential monitoring of multiple stations.
- Dispatches and directs SMS-text or email messages to specific individuals for various alarm conditions; logs alarms chronologically with the internal real-time clock.
- Intuitive, menu-driven front-panel setup. The built-in Web server allows remote setup and full operation over any IP network. Supports SNMP remote monitoring.
- The built-in BandScanner™ utility gives a spectrum plot of the entire FM band or a specific portion, and identifies stations through RDS and HD PAD data.



# SOFIA 568 TECHNICAL SPECIFICATIONS

**Tuning Range:** 87.5MHz-107.9MHz in 100kHz steps

**Antenna Input:** 75-ohm (BNC)

**Sensitivity/SNR:** 10dBuV required for 50dB unweighted, monaural analog-FM S/N

**Off-Air Frequency Response:**

**FM:** ±1dB, 20Hz-15kHz

**HD Radio:** ±0.25dB, 20Hz-20kHz

**FM De-emphasis:** 75µs, 50µs or none, menu-selectable

**Reception Modes:**

**FM:** Stereo / Stereo Auto-Blend / Forced-Monaural

**HD Radio:** HD1 through HD8; 'Split Mode' delivers L+R FM to the left audio channel and L+R HD1 to the right.

**RDS Fields Displayed:**

PS, PI (and Call), RT, RT+1, RT+2, PTY, PTYN, CT, M/S, DI, TP, TA; RDS Block Error Rate, Groups Transmitted (with use statistics), AF, ODA.

**HD PAD Data Displayed:**

**SIS:** Short Name, Universal Name, Station ID, Slogan, Message, Station Location.

**Misc:** Service Mode, Codec Mode, TX Gain, TX Blend Control.

**PSD (HD1-HD8, each):** Slogan, PTY, Artist, Title, Album, Logo and/or Artist Experience graphics.

**Graphs and Metering:**

L, R, L+R, L-R Program Audio; Audio (Loudness) Histogram; RSSI, RF SNR, HD Level and Cd/No levels and histograms.

**Program Audio Outputs:**

**Balanced Analog:** (XLR) Left and Right outputs, adjustable from -15dBu to +15dBu in 0.1dB steps.

**AES Digital:** (XLR) output at 44.1kHz or 48kHz, adjustable from -30dBFS to 0dBFS in 0.1dB steps.

**Dante/AES67 Compatible:** (RJ45) AoIP output at 44.1kHz (Dante) or 48kHz (Dante/AES67) is adjustable from -30dBFS to 0dBFS in 0.1dB steps.

**Headphone Jack:** (3.5mm TRS) with adjustable listening level.

**Streaming Audio:**

Web-browser 'remote listening' stream has selectable MP3 or OGG encoding and offers bit-rates from 32kbps to 256kbps and sample rates from 16kHz to 48kHz; accommodates up to 10 simultaneous listeners. HTTP/Icecast and raw UDP streams simultaneously available.

**Alarms:**

**Audio Loss:** Alarm responds to the monitored service (FM or HD Radio). Alarm On/Off thresholds and Time On/Off intervals are programmable.

**Low Signal:** Alarm and reset trigger levels are independently adjustable relative to the FM carrier level display and have programmable Time On/Off settings.

**RDS Alarm:** Programmable Time On/Off for RDS Loss or PI Error.

**Pilot Loss:** Programmable Time On/Off for loss of Stereo Pilot.

**HD Loss:** Fixed metrics determine loss of HD Radio reception; programmable Time On/Off.

**Email Alerts:** Email or SMS/text-messaging alerts selected personnel to specific alarms.

**Alarm 'Tallies':** Individual open-collector NPN transistor outputs to ground are programmable for logic polarity and GPO assignment.

**Real-Time Clock:**

Auto-sets to Internet time; auto/manual DST setting; battery backup.

**AoIP Port:**

Dante-based, AES67-compatible (selectable) AoIP utility has independent IP, Audio Format and Transmit Flow settings.

**LAN Port:**

LAN connection to local network or Internet provides remote monitoring, listening and control; user-programmable network setup and streaming parameters.

**Power Requirement:**

12VDC at 450mA; a universal 88-264VAC inline switching power supply is included.

**Mounting Options:**

An optional rack adapter mounts one or two half-rack modules in a 1U, 19-inch rack space.

**Operating Environment:** 32°F/0°C-

122°F/50°C; 0% - 95% non-condensing relative humidity; 10,000ft/3048m

**Size and Weight:**

1.6"H x 8"W x 6"D; 5 lbs. shipping weight.

**Conformances:**



EN50081-1  
EN50082-1  
93/68/EEC



2002/95/EC

## BLOCK DIAGRAM

The SOFIA 568 incorporates a Software-Defined Radio (SDR) receiver, and other elements in its design that make the product almost entirely DSP-based. Virtually all functionality is provided through firmware coding. The Block Diagram presented here illustrates product basics in an easily-understood form, although actual signal paths and logical functions may deviate appreciably from the signal paths shown.

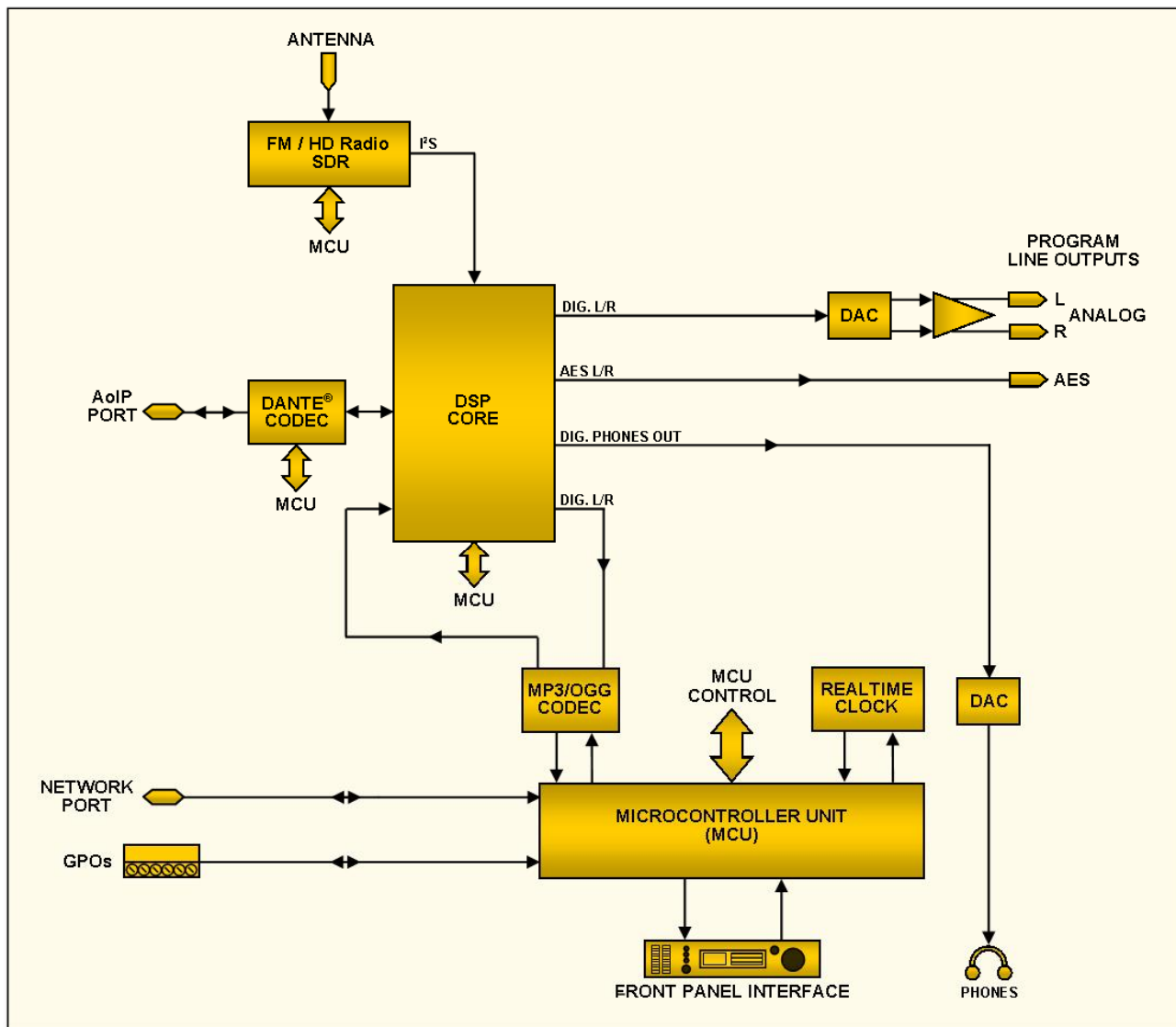

Block Diagram – SOFIA 568 HD Radio SiteStreamer+

## Section II

# INSTALLATION

### GENERAL

This section of the manual addresses the physical installation of the SOFIA 568 at its operating location, the ‘nuts and bolts’ of connecting the unit. This section also references pages where pertinent setup adjustments are discussed.

#### **Unpacking and Inspection**

As soon as the equipment is received, inspect carefully for any shipping damage. If damage is found or suspected, notify the carrier at once, and then contact Inovonics.

We recommend that you retain the original shipping carton and packing materials for possible return or transshipment. If returned for Warranty repair, shipping damage sustained as a result of improper packing for return may invalidate the Warranty!

**IT IS IMPORTANT** to register the Warranty of your SOFIA 568. This assures coverage of the equipment under Warranty terms, provides a means of tracing lost or stolen gear, and adds the user to a database to receive specific service instructions or software/firmware updates when issued. Register online at:

[www.inovonicsbroadcast.com/support/productRegistration](http://www.inovonicsbroadcast.com/support/productRegistration)

***NOTE:*** Many users choose first to familiarize themselves with equipment on the bench or at their desk, in which case they may immediately turn to Section III that describes SOFIA 568 setup and use. When the time comes, do please refer back to this section to confirm proper physical installation and interconnection with other station equipment.

### MOUNTING, POWER AND ENVIRONMENT

#### **Rack Requirement**

The optional 1U rack-mount chassis will accommodate either one or two half-rack Inovonics modules, or one half-rack and one one-third-rack size in the INOmini series.

#### **Heat Dissipation**

Consuming little power, the SOFIA 568 itself generates negligible heat, thus no noisy internal fan and bothersome filter. The unit is specified for operation within an ambient temperature range between freezing and 120°F/50°C. Because adjacent gear may radiate substantial heat, be sure that the equipment rack is adequately ventilated to keep internal temperature below the specified maximum ambient.

**AC Mains Power** The SOFIA 568 is provided with an external, inline ‘universal’ switching power supply that accommodates mains voltages between 88VAC and 264VAC. Self-protection circuits obviate the need for an external fuse.

The power supply has a detachable IEC-type power cord fitted with a North-American-standard male plug. If you need to replace the mains plug with another, you will find that the individual cord conductors are color-coded in one of two ways. US standards specify black for AC ‘hot,’ white for AC neutral and green for earth ground. European CEE standards specify brown for AC ‘hot,’ blue for AC neutral and green with a yellow stripe for earth ground. Please don’t mix these up.

**Radio Frequency Interference (RFI)** Although it is expected that the SOFIA 568 will be co-located with other radio equipment, do practice care and common sense in locating the unit away from *abnormally* high RF fields.

**Ground Loops** A mains frequency or RF ground loop could possibly be formed between cable shield grounds and the AC power cord ground. If hum or other constant noise is noted, a ‘ground-lifting’ AC adapter may remedy the problem, although the chassis must somehow be returned to earth ground for safety. The optional rack-mount chassis should satisfy this requirement.

## INPUTS, OUTPUTS AND PORTS

**Antenna Input and Considerations** The rear-panel ANTENNA connector is a female, 75-ohm BNC connector. While the BNC may be an atypical antenna connector, it is nonetheless ubiquitous worldwide, and adapters to other connector types are readily available.

Many factors will guide your selection of an antenna, not the least of which is the level and purity of the available off-air signal. Although the selectivity of the SOFIA 568 is remarkably good, it’s not impossible that a band-pass or band-stop filter may be required for situations where the receiver is co-located with high power FM transmitters.

**Analog Line Outputs** Male XLR left- and right-channel ANALOG OUTPUTS on the rear panel are electronically-balanced. This means that they are ground-referenced and *not* transformer-isolated.

Analog line outputs may be adjusted under the front-panel Setup / Audio Outputs / Analog Level menu. These may be set to any level between  $-15\text{dBu}$  and  $+15\text{dBu}$ , corresponding to 100% modulation. The dB levels shown beside the slider control represent the *unloaded* output level. These outputs have a resistive source impedance of 200 ohms. Feeding a 600-ohm-terminated load will drop the actual dBm level 2.5dB below the figure shown by the slider.

<b>Unbalanced Operation</b>	<p>If the analog line outputs of the SOFIA 568 are connected to low-level, unbalanced inputs of consumer-grade equipment, connect the center conductor of the shielded output lead to Pin 2 of the XLR connector and the shield to Pin 1. Leave Pin 3 unconnected.</p> <p>Driving unbalanced lines, the actual output level will be 6dB lower than the Analog Level shown in the menu, as only one side of the bridge-configuration output stage is driving the load.</p>
<b>AES Digital Line Output</b>	<p>The male XLR connector labeled AES DIGITAL OUTPUT is a balanced, transformer-coupled digital AES3 stereo program output. This is a 24-bit output at either a 44.1kHz or a 48kHz sample rate (follows Dante sample rate settings, see Page 33).</p> <p>The digital output level is set on the Setup / Audio Outputs / Digital Level menu. The dBFS notation beside the slider control corresponds to the level of program peaks at 100% modulation (<math>\pm 75\text{kHz}</math> FM carrier deviation). The level is adjustable between 0dBFS and <math>-30\text{dBFS}</math>.</p>
<b>AoIP Streaming Port and Levels</b>	<p>The Dante-compliant AoIP (Audio over Internet Protocol) output appears at the rear-panel RJ45 AoIP PORT. This port is independent of the SOFIA 568 LAN PORT network connection.</p> <p>The AoIP streaming output level is set on the Setup / Audio Outputs / AoIP Level menu. The dB notation beside the slider control corresponds to the level of program peaks at 100% modulation (<math>\pm 75\text{kHz}</math> FM carrier deviation). This level is adjustable between 0dBFS and <math>-30\text{dBFS}</math>.</p>
<b>LAN Network Port</b>	<p>The RJ45 LAN PORT jack is used for networking the SOFIA 568 via a Local Area Network (LAN) or the Internet. Networking permits full remote control, and the HTTP/UDP Web-browser ‘casual listening’ utility can accommodate up to 10 simultaneous listeners. The LAN PORT also offers full SNMP functionality. Networking setup is explained starting on Page 32.</p>
<b>GPOs</b>	<p>A removable screw-terminal strip on the rear panel gives access to four GPO (General-Purpose Output) terminals. GPOs may be assigned to reception- and program-fault alarms. Programming these terminals is detailed on Page 31.</p> <p>GPOs are NPN transistors that saturate to ground and can sink up to 100mA. Alarm polarity (active for ground or active on open) is programmable through software.</p>

# Section III

## SETUP AND OPERATION

### PRELIMINARY INFORMATION

**Quick Boot** 'Boot' (startup) time of SOFIA 568 is about five seconds. When power is first applied, or following a power interruption, the unit is back in full operation very quickly. Setup and reception parameters in use previous to the power glitch are reloaded instantly from non-volatile memory into the processing core.

**Front Panel vs. Web Interface Setup** The SOFIA 568 may be placed in *initial* service either through local, front-panel setup or by using the Web interface. Although a good number of SOFIA 568 functions and features are addressable only through the Web interface, some familiarity with front-panel operation is necessary to get the unit up and running.

### THE SOFIA 568 FRONT PANEL

All setup and operating adjustments of the SOFIA 568 are under firmware control. There are no jumpers, switches or mechanical potentiometers, only the front-panel jog-wheel knob A and Back button B identified in this front-panel rendering.



#### The Jog-Wheel Knob

Turn the jog-wheel knob A to cycle the highlight through the various menu options, then *push* the knob to select the highlighted item. This will move you to the next submenu, and there may be multiple menu levels for the item you need to reach. Once you do reach a submenu that allows control over a function, you *turn* the knob to bracket the adjustable function, and then *push* to access that function. The bracketed item will begin flashing, and you *push* or *turn* as required to make a selection, to set an adjustable parameter, or even to enter text.

If you dawdle or simply walk away, after 30 seconds of no further knob activity the SOFIA 568 will enter a selection you have

made into memory automatically, or simply ‘deselect’ the highlighted item if it has not been altered.

**The BACK Button** BACK button B will always return you to the previous menu screen. Push it repeatedly to go back to the Main Menu shown in the illustration.

If you make a mistake (for example, you might *push* the knob slightly off-center, which could also rotate the knob and bring up the wrong menu), simply push the BACK button to return to the previous menu and try again.

**Graphic Display** OLED graphic display screen C presents an abbreviated, intuitive setup menu tree in an easy-to-follow format. The display uses a screen saver, so if the screen goes dim or dark, simply *push* the jog-wheel knob or BACK button once to bring it back to life. No selection or change is made with this ‘wake-up call.’

**Local Alarms** Front-panel alarm LEDs D indicate critical reception errors. Programming the alarm thresholds and delays is accomplished through the Web interface as described starting on Page 26.

**Level Meters** LED-segment meters E are LEFT and RIGHT channel audio level indicators with peak response to program dynamics. A floating peak-hold segment catches the most recent peak level.

The full-scale 0dB reference corresponds to  $\pm 75\text{kHz}$  monaural-FM modulation or nominal 100% HD Radio modulation. Meter scaling is linear at 3dB per segment down to  $-18\text{dB}$ , then 6dB per segment to  $-30\text{dB}$ .  $-60\text{dB}$  at the bottom is essentially the peak-weighted noise floor for analog FM.

Because these meters are peak- rather than averaging- or VU-responding, you’ll find that they will typically hover right at the top of the scale during most music programming, which nowadays has very limited dynamic range.

**Menu Timeout and Screensaver** After making and saving a setting, you may press the BACK button to return to the Main Menu screen, or simply leave any current screen showing.

A programmed interval may be set under the Admin / Display menu to adjust screen brightness and to dim or turn off the OLED screen when the SOFIA 568 is unattended. This is a recommended practice that prolongs the life of the display. At any time, however you can press the jog-wheel knob or BACK button to bring-up the OLED screen.

## THE FRONT-PANEL MENU TREE

The several levels of front-panel setup and operating menus are laid out in an intuitive and easy-to-manage fashion. The complete Menu Tree is shown and explained below. Keep in mind that the front-panel Menu Tree is a much-abbreviated version of the total SOFIA 568 setup and operation navigation.

Menu Titles are shown here in a font similar to the OLED display font. Primary menu items are against the left margin and sub-menu levels are indented appropriately.

Menu items shown here are tagged to show whether the item is a readout (display) of some parameter, or if it accepts some form of user entry (data entry). (set) signifies an on/off or enable/disable function, and (select) denotes user control over multiple-choice selections, or for adjusting some value in very small increments. (data entry) calls for alphanumeric character entry into data fields. Data entry is a bit cumbersome with the jog-wheel knob and is much more easily done through the Web interface.

### SOFIA 568 FRONT-PANEL MENU TREE

Now Playing	Setup (continued)
Freq (display)	Network
PI (display)	IP Settings
Call (display)	DHCP (set)
RSSI (display)	IP (data entry)
DQ (display)	Subnet (data entry)
CdNo (display)	Gateway (data entry)
PS (display)	DNS (data entry)
RT (display)	Hostname (data entry)
Title (display)	HTTP Port (data entry)
Artist (display)	MAC (display)
Tuner	Speed ( <i>Link Speed</i> ) (display)
Frequency (select)	Time
Mode (FM/HD) (select)	Time Zone (select)
Split Mode (set)	DST (select)
RSSI (display)	Format (set X2)
SNR (display)	Server (data entry)
DQ (display)	AoIP/Dante (programmable only through
CdNo (display)	the Web interface)
Station Rotation	DHCP (display)
Enable (set)	IP (display)
Rotation Time (select)	Subnet (display)
Setup	Gateway (display)
Radio	DNS (display)
De-Emphasis (select)	MAC (display)
Stereo/Mono (select)	Speed (display)
RDS/RBDS (set)	Admin
Audio Outputs	Security ( <i>Passwords</i> )
Analog Level (select)	Front Panel (data entry)
Digital Level (select)	Webpages (user) (data entry)
AoIP Level (select)	Webpages (admin) (data entry)
General Purpose Outputs	Display
Output 1-4 (select)	Brightness (set)
Polarity (set)	Timeout (set)
Type (select)	Dim on timeout (select)
Status (display)	About
	Firmware Rev (display)
	Serial # (display)
	Uptime (display)
	Headphone Volume
	Volume (set)



## GETTING UP AND RUNNING

Some of this information echoes instructions found in the Quick Start Guide (QSG) that accompanies the SOFIA 568.

**The Main Menu** Push the BACK button until you see the Main Menu on the OLED display. This is the 'gateway' for setup and operation.



With the SOFIA 568 connected to your local network (LAN), use the jog wheel to navigate from the Main Menu to: Setup / Network / IP Settings.

**Finding the SOFIA 568's IP Address**

This image is typical of what your unit should now display. Under the default  DHCP control selection, your router should have assigned the SOFIA 568 an IP address. In this example the DHCP assignment is IP: 192.168.0.102. Note that this menu screen holds more IP address information; turn the knob to scroll down.



**Assigning a Fixed IP Address**

To assign the SOFIA 568 a fixed IP address, clear the  DHCP box and then navigate through the various fields on this screen, entering the called-for information manually in each. Be sure to execute a Save after entering the IP data in each field.

**Connecting to the SOFIA 568**

On your computer connected to the same network, open a browser window and enter the SOFIA 568 IP address into the address bar using the IP: displayed on the front-panel OLED screen. The Now Playing screen should pop-up like the one shown here.

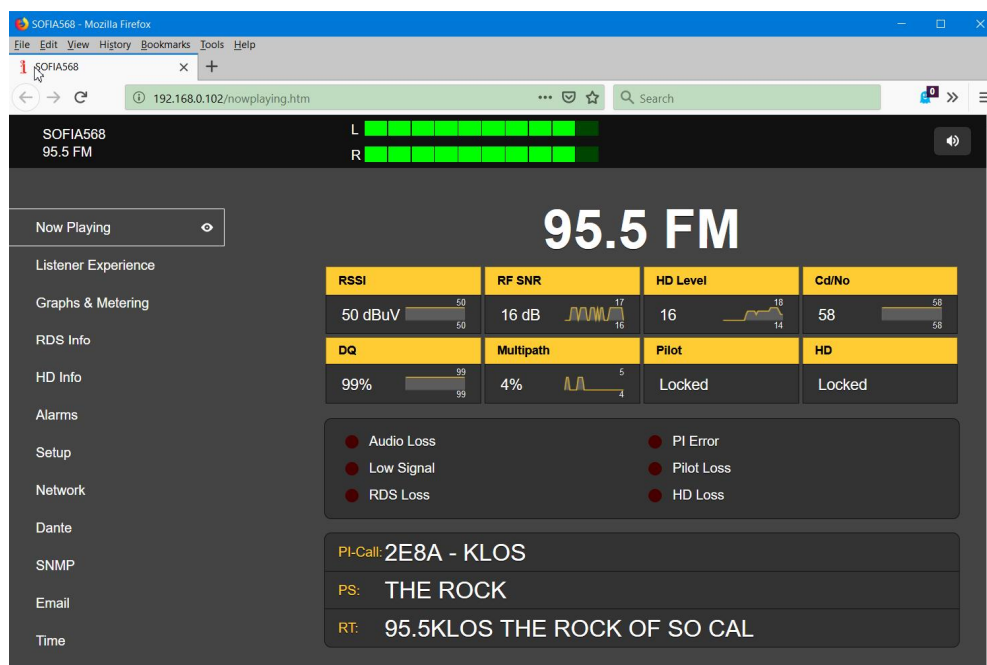

The ‘responsive’ design of the SOFIA 568 Web interface provides an optimal viewing experience across a wide range of devices, such as desktop computers, tablets, and mobile phones.

SOFIA 568 Webpages feature the unabridged Main Menu on the left-hand side of the screen. This columnar list appears on every Web interface screen. It is a substantial expansion of the front-panel Main Menu and a testament to the many features and their setup options that can only be addressed using the Web interface.

The remainder of this manual section will be devoted to individual explanations of each left-column menu item, discussed in listed order. Subtopics will generally be discussed from the top of the screen down.

## NOW PLAYING

The SOFIA 568 offers an array of OLED and Web interface meters and data readouts useful for setup and for monitoring program-associated metadata and certain important signal parameters.

### Remote Listening

What you can hear at the remote location will be predicated on the ‘what’ and ‘how’ settings discussed a bit further-on in this section. You can click the loudspeaker icon at the top-right of the screen to listen to the off-air audio program through your Web browser.

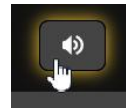

Alternatively, you may use the IP address method with the address bar of any browser or player (e.g., VLC Media Player). In other words, it is not necessary to use the formal Web interface utility to listen-in. The address-bar entry should resemble this example, with the SOFIA’s IP address and port number followed by a slash and the word ‘stream.’



**NOTE:** Selected programming will be the same for ‘casual’ Web-listening audio streaming (HTTP and UDP), the separate AoIP-streaming utility, and the rear-panel analog and AES-digital program line outputs. Whatever listening choice you make will be heard on *all* audio monitor functions.

A complete discussion of SOFIA 568 modes and tuning starts on the next page.

### ‘VU’ Meter

As explained earlier, SOFIA 568 metering is peak-responding. The Web interface display follows the 10-segment front-panel LED bar readout; see Page 13 for additional details. Metering with higher resolution is displayed on the Graphs & Metering Web interface page and are covered under that discussion.

### Signal Metrics

Directly below the prominent frequency notation near the top of the page, you’ll find a cluster of off-air signal quality readouts.

With the exception of Pilot and HD, which only indicate an unlocked, a syncing or a locked condition, each of the other six quality notations is accompanied by a scrolling 30-second graphical history of the associated readout, plus low and high values for the same period.

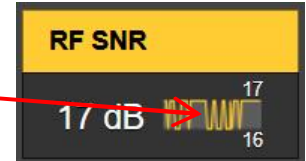

Here's a synopsis of the parameters shown: RSSI is received signal carrier strength in dBuV; RF SNR is a generalized signal/noise figure for the off-air signal; HD Level is a relative level measurement of the HD Radio carrier pair; CD/No and DQ are relative quality assessments of the decoded HD Radio digital information based on error statistics, CD/No best representing HD Radio reception quality; Multipath is a relative measurement of multipath (direct/reflected) distortion effects. The signal quality measurements will prove useful when setting-up a receive antenna. Pilot and HD simply indicate Locked or No Lock.

#### **Alarms**

The SOFIA 568 offers alarm indications for various signal-related issues. Alarm status is displayed on the front panel, below the signal metrics readout here on the Now Playing Webpage, and on the Alarms Webpage where the alarm trigger and reset parameters are set. Alarm specifics and setup procedures begin on Page 26.

In addition to the alarm status indicators, the individual alarms can be assigned to rear-panel GPO terminals to tie into remote control systems, light accessory indicators, or trigger a siren, etc. GPO programming is explained on Page 31.

Alarms can also send email or SMS/text messages to specific personnel. This is detailed beginning on Page 35.

#### **Audio Program Metadata**

The SOFIA 568 displays metadata associated with the audio program being monitored.

When analog FM is selected as the source, the RDS (Radio Data System) PI-Call: (PI code and call letters), the static or scrolling PS: (Program Service) field and RT: (RadioText) messaging is shown.

When listening to HD Radio transmissions, the readout will instead display PAD (Program Associated Data) information; the station Name: and Slogan:, and the Artist: and Title: of the song currently playing.

#### **Tuning and Program Selection**

The SOFIA 568 is easily tuned from the front panel Tuner menu, or from the Tuner section of the Now Playing Webpage. Overtyping an FM frequency into the box to the right of Frequency (MHz);, or you can grab the slider knob and drag it back and forth. Or click on the slider knob and, once it's highlighted, use your keyboard arrow keys to move up and down the dial. The on-screen arrows do likewise.

The monitored audio source, or ‘what’ you hear, is selected manually, either from the front panel under the Tuner menu, or on this same Now Playing Web interface page.

Scroll down the page, and under the Tuner heading, click on any of the active (not grayed-out) Program: buttons to select either the analog-FM transmission, any of the active HD Radio channels, or the ‘blending’ FM/HD1 selection detailed below.



‘How’ you hear the streamed audio is dictated by settings under Setup / AUDIO OUTPUTS / Stream. Briefly navigate to that Web interface page and check the default settings. You will find that the streaming Format:, Bitrate: and Sample Rate: may be changed from the default settings as may be required to accommodate inconsistent network quality. Other factors relating to the streamed listening can be found on Page 30. The independent AoIP audio streaming provision is discussed separately on Page 33.

Next to Program: click one of the buttons to manually select FM, any of the HD1 through HD8 channels to monitor. Active and available FM or HD Radio channels will be identified with white lettering, unavailable options will be grayed-out.

The last listening selection, FM/HD1, causes the SOFIA 568 to emulate the blending function of a consumer radio. That is, when the HD1 digital transmission cannot be recovered, the radio blends to analog FM. But keep in mind that in all other circumstances, when the SOFIA 568 is tuned to an HD Radio broadcast and the digital signal is lost, *the receiver does not automatically revert to analog-FM reception.*

### The Split Mode

The SOFIA 568 can be used for a first-order verification of analog FM and digital HD1 transmission sync. Click Split Mode: On to hear the HD1 program in the left channel and the FM program in the right. The two programs you hear will each be L+R monaural, and any audible delay, echo or ‘hollowness’ will justify looking into your Diversity Delay exciter or processor settings. Be sure to turn Split Mode: Off after listening for program sync.

### Station Presets

You may enter as many as 30 station-memory Preset Stations. Preset memories hold not only the tuner settings, but all alarms individually chosen for that station as well.



Simply tune to the station you wish to save and click on the Save as New bar. The entry you save will also hold the recep-

tion mode, so you can generate separate entries for the FM and HD channels of your station.

Station presets are deleted by clicking on the **✕** at the far right of the listing.

**StationRotation™** The SOFIA 568 is capable of sequencing through all the saved Preset Stations entries in the order listed, and at a rate set by the user. This might allow a contract engineer to receive alarms from any of a number of stations he might service in a given market.

First, StationRotation must be turned on by setting Enable: to On. This will inhibit manual tuning, graying-out the manual Tuner setup section completely. Next the Rotation Time (Sec): is programmed, and this takes some planning.

When the SOFIA 568 is first tuned to an HD Radio program, it takes about eight seconds to acquire, buffer and begin delivering the program audio. This is not a consideration for analog-FM-only broadcasts, but if even one HD program is included in the Preset Stations listing, then timing must be set for a minimum of 30 seconds, maybe 60 seconds to be absolutely sure.

There are additional alarm setup considerations when using the StationRotation feature. Most alarms have time-on/time/off settings that will directly impact the Rotation Time (Sec): setting. See the Alarms discussion beginning on Page 26.

The Status: display gives a second-by-second countdown of rotation time.

## THE LISTENER EXPERIENCE

**Definition** The term 'Listener Experience' encompasses both the metadata (artist/title, etc.) text for both the FM and HD Radio programs, plus the graphic imaging that can optionally accompany each HD Radio channel. Images can include primary station-identification tiles, called Logos, and music album artwork or program-promotion messages, called Artist Experience.

**Display Options** Once a station is tuned, the Listener Experience material will take some time to load. Setup options at the top of the page determine how metadata and graphics are displayed. This Web interface page not only displays what a consumer receiver shows at the moment, but it collects and saves image files and their descriptors for later analysis as well.

You'll find buttons for analog-FM and all eight HD Radio programs at the top of the page. Any of these buttons may be selected, whether the tuned station has HD programs or not. Selecting these simply creates a display area farther-down on the page for the associated data and images. To save space, select only those buttons that are pertinent to the station and programs you are monitoring. The Tuner section of the Now Playing

page will always alert you to the program channels that are active on any given station.

The more important RDS data that accompany the analog-FM program is presented topmost. HD Radio PAD info and graphics are stacked below that.

For HD Radio program channels there is another selectable display option: Simple | Listener or Advanced | Broadcaster. The first is the consumer-receiver view, the second the archived graphics history, respectively.

The left-hand screenshot in the following illustration is the Advanced | Broadcaster view of the HD1 metadata and graphics archive. The boxed image is album art for the song currently playing. The two to the right are album art for the previous two songs.

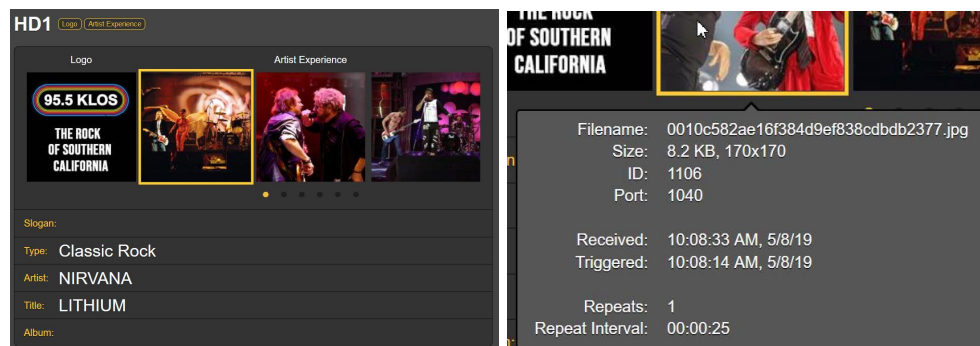

Click the little dots below the images to scroll through the previous 17 Artist Experience graphic images.

Hover over any image to bring up image specifications as shown in the right-hand screenshot above. These specs define the received image file.

### Image Error Reporting

SOFIA 568 diagnostics alert you to an image that does not meet the HD Radio spec, images that may not display properly on radio faceplates. Just hover over the image to bring up the Image Issue(s): info box. If it's your own station that you are monitoring, you may want to click on the first yellow link in the box to be whisked-away to an industry Website where you can upload the off-air image for an instant evaluation and explanation of the problem. In this particular case, specific characters in the image filename did not match the station's 'short name.'

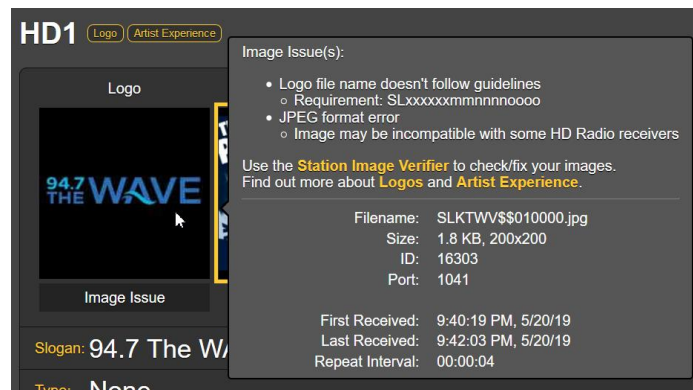

The other two yellow links bring up technical particulars relating to the specifications for both the station Logo tile and Artist Experience images. This self-help Website will also direct you to independent sources for assistance in formatting HD Radio images properly.

The Listener Experience display for other HD Radio channels this station carries will be presented in like manner. Remember that any transmitted HD channel must be selected at the top of the page before it will be presented.

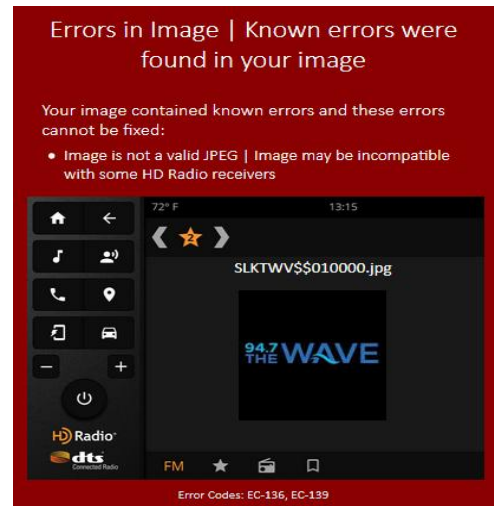

**Additional Image Data**

Additional information relating to received image files is found under HD Info / Programs/ Image Data. This will be explained in the discussion for that Web interface menu.

**GRAPHS & METERING**

**Audio Level Metering**

Near the top of this Web interface page you'll find an audio level metering utility with significantly greater resolution than the 10-segment front-panel LED or its on-screen counterpart that headlines every Web interface page. Levels for both the Left and Right channels and the L+R/L-R stereo sum/difference are shown with linear-dB scaling.

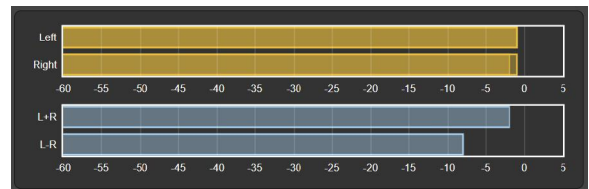

The full-scale, 0dB point corresponds to  $\pm 75$ kHz monaural analog-FM deviation, or nominal full-scale modulation of any HD Radio digital channel. See Page 13 for other metering caveats.

Keep in mind that this metering applies solely to the service that you have selected for listening. If you are listening to FM, that's the audio you see. If you have punched-up HD3 on the Now Playing page, then that's what you're looking at. This may seem a no-brainer, but it has implications that we'll soon reveal.

**Histograms**

The next section on this Web interface page presents two 'rolling histograms,' or constantly-updated plots-over-time of several signal metrics.

The information shown here actually accumulates over the entire previous 24-hour period. The Time Span: setting below the graphs sets the time period displayed. Options are the last 1 Minute, the last 10 Minutes, the last 1 Hour, the last 6 Hours, or the entire previous 24 Hours. Click on these buttons to change the time period presented, or click anywhere within in the area to cycle through the options.



The upper graph shows Left and Right program channel levels over the selected time period. These levels reflect the unit's peak-weighted metering, and although they do not represent true loudness, one can get a pretty good idea of program audio density from this plot.

The lower graph plots signal metrics over time. The display defaults to a display of all four parameters available, although the Show: buttons allow for selective presentation. Y-axis resolution increases as display choices are reduced.

Obviously, the histograms represent only the station being received at the moment. If you change frequency to check on other stations in the market, the histograms will reflect parameters of those stations during your surfing expedition. You might want to jot-down the time away from the primary station target if the histograms will be used for later analysis.

**The  
BandScanner™  
Utility**

The BandScanner utility of the SOFIA 568 is a simple, annotated RF spectrum analyzer. It displays the entire FM band when Step Size: is set to the default 200kHz, regardless of the Center Frequency (MHz): setting. Center Frequency (MHz): and Step Size: may be selectively adjusted to zero-in on a frequency range of interest.

*NOTE:* The band-scanning function mutes receiver audio during the scan cycle and will put a glitch in the histograms as it essentially tunes across the band and downloads data from each station in the market. This is another of the implications alluded-to earlier with respect to metering, histograms and FM band-surfing.

There are three scanning modes, or Scan Type: selections. The SOFIA 568 can scan the band and display only the RSSI level; this is the quickest scan. It can also scan and display both the RSSI + RDS information, which takes a bit longer, or it can scan and display RSSI + RDS + HD information which is effectively a double-scan of the band.



This is an entire FM-band plot of the busy Los Angeles FM market, scanned in the RSSI + RDS + HD mode.

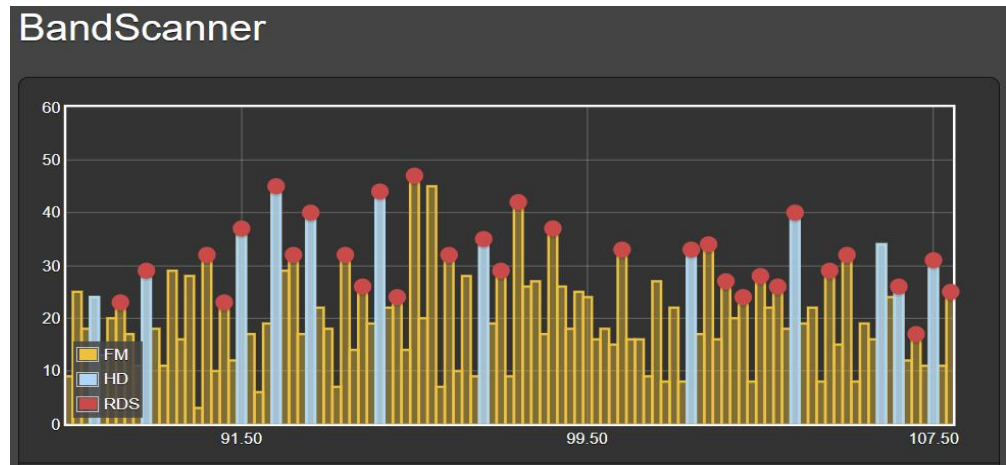

Every FM carrier found is displayed as a vertical bar, the height indicating the relative signal strength in dBuV per the annotation to the left of the plot. Had this scan been done in the simple RSSI: mode, all stations would show up as yellow bars.

By 'hovering' over a yellow bar, the Freq: and RSSI: level are shown numerically in the pop-up, as in the first example on the right.

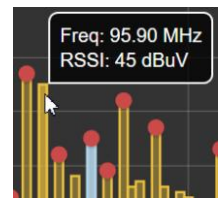

A yellow bar with a red dot indicates that the station carries RDS information. (The red dot shows only when the Scan Type: is set to RSSI + RDS or RSSI + RDS + HD.) Hovering over the red dot will display Freq: and RSSI:, plus the RDS PI: code and derived Call: letters, plus the PTY, or programming format of the station. This is exemplified in the second example on the right.

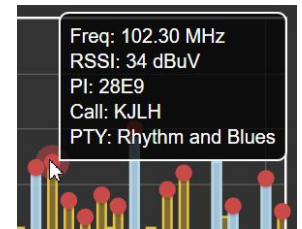

Running a full RSSI + RDS + HD scan additionally shows the HD stations in the market as blue bars, which are invariably topped with red dots indicating RDS info as well. In the third example here, hovering on the blue portion of the bar brings up Freq:, RSSI: and Cd/No: (digital signal quality) stats, as well as which HD Radio Programs: (channels) are being broadcast, and the short station Name:. To see RDS info for this station, just hover over the red dot at the top of the bar.

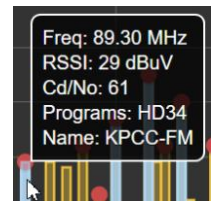

Market stations with RDS are shown in an RDS Stations: list directly below the scan. These are listed in ascending frequency along with their PI, callsign, PTY and RSSI values. Click on any station's frequency to immediately tune the SOFIA 568 to that station and be taken to the Now Playing Web interface page.

The HD Stations: list is below the tabulation of RDS Stations:. Again in ascending frequency, the information will include

which HD Radio programs are being transmitted, the station name, the RSSI value, and the Cd/No figure denoting relative quality of the digital signal.

The Cd/No notation is color-coded in this list. A value greater than 57 that gives solid HD Radio reception will be green, an orange number is 'iffy,' and a red one generally won't play.

## RDS INFO

As the menu title implies, this Web interface page is a comprehensive display of the RDS information accompanying analog-FM transmissions and their programming. It isn't within the scope of this manual to introduce, define and describe RDS features, data, formatting and grouping. For that the reader is directed to the appropriate Standard for either the European RDS or US RBDS RadioData housekeeping utility.

### RDS Data Display

The top area of the screen shows the most important blocks of RDS data: the static or scrolling PS; the PI Code, either assigned or, in the US and Canada, derived from the Callsign; RadioText and its interactive RT+1 and RT+2 derivatives; plus the various IDs and 'flags' that assist RDS receivers in responding to system commands.

A bit down the page is an analysis of the RDS Block Error Rate, useful in troubleshooting RDS problems. You'll also find a statistical presentation of all RDS data 'groups,' including the percentage of the data total each group carries.

If the station has an AF List, those Alternative Frequencies are totaled and displayed. Proprietary Open Data Applications (ODA channels) are similarly totaled and listed.

Alternative Frequencies		Open Data Applications	
AF1	90.7	12B	0x464B
AF2	98.5		
AF3	93.7		

A Clear/Reset RDS command does indeed clear the registers and begins a new RDS data collection. Reset is automatic when the station is changed.

## HD INFO

### Housekeeping

SIS, or Station Information Service, includes station-identification and technical data that each broadcaster who transmits HD Radio programming is obliged to provide. Even the transmitter location is pinpointed with its GPS coordinates, which you can click-on to bring up a Google Maps image of the transmitter site. (Kinda scary!)

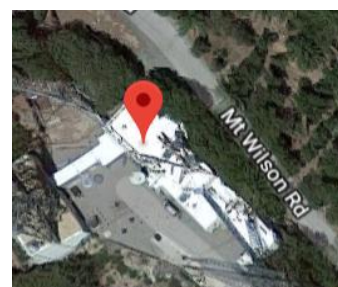

Miscellaneous provides additional specifics on HD Radio coding and transmission.

**Program-Specific Information**

The Program area of the screen supplies information pertinent to the programming of each HD Radio channel transmitted by the monitored station. Current program station logos and album art for all HD channels are presented at the top of this display area, and then each HD channel is detailed underneath.

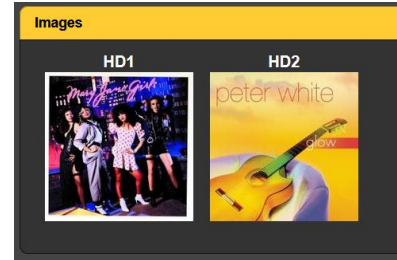

**Image Data**

Each HD channel presentation echoes the primary program-associated data provided on the Listener Experience page, but in addition gives statistical information for HD Radio images.

Image Data are shown as-received in a rolling real-time plot of the most recent data packets. The time period is variable as the plot is capable of displaying only a certain number of events.

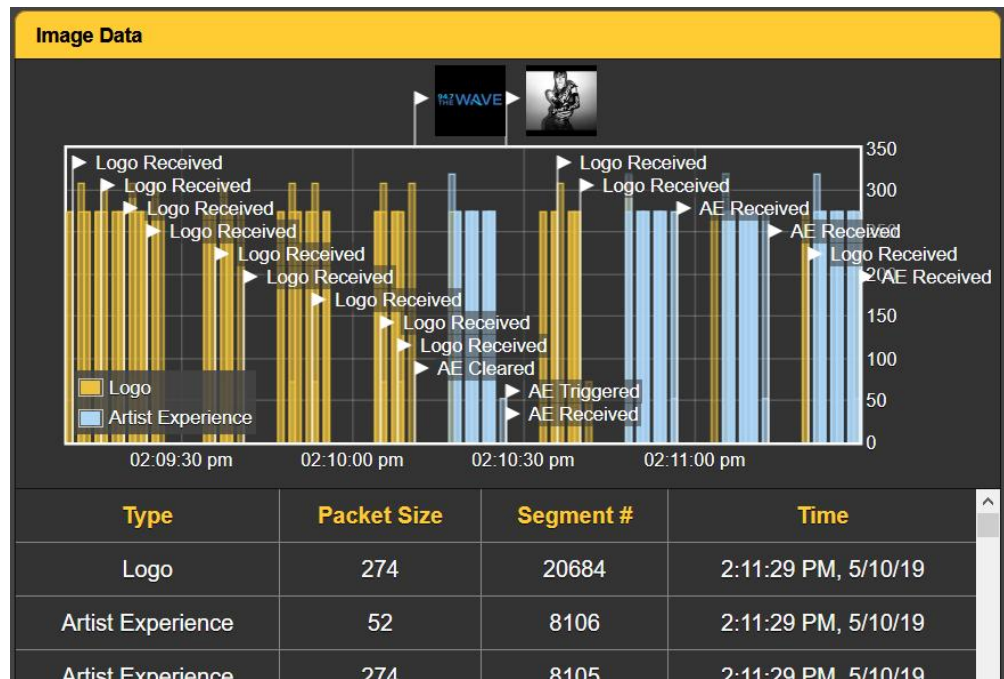

Just below the rolling graphic display of Image Data, information is further clarified in tabular form. The tabulation assigns absolute values to Packet Size, Segment # and Time. This tabulation is 'rolling' as well, showing the same events as the graphical presentation. This information includes the times that images are received and cleared, and verifies the repeat interval. All this is useful in troubleshooting HD Radio image display problems.

# ALARMS

**Alarm Status** The SOFIA 568 provides alarms for a total of 12 signal or program-related error conditions.

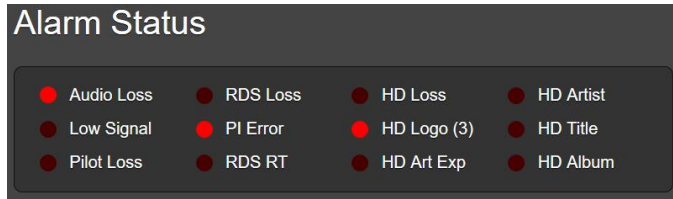

All twelve alarms give flashing notifications on the front-panel OLED screen, and are indicated in the Alarm Status area of this Web interface page as shown here. All twelve are also able to initiate email or SMS/text messages to selected personnel, and alarms are logged for later analysis or finger-pointing.

Three major alarms are represented by LED indicators on the SOFIA 568 front panel, and up to four alarm conditions may be assigned to rear-panel GPO 'tally' outputs to interface with remote-control equipment or local lights and sirens.

Alarm conditions must first be set-up as described in the remainder of this section. Following that, the email/SMS messaging and rear-panel GPO tallies may be programmed. These procedures will be described in the Setup and Email Webpage discussions, respectively.

*NOTE:* Do please read the following discussions in their entirety. A setup explained for one alarm that is common (or quite similar) to the setup of others may not be explained in full detail a second time.

**Audio Loss** Alarm: On simply 'arms' the function in this and all similar instances. If the alarm is turned Off, there will be no front-panel AUDIO LOSS LED or corresponding indicator on the Web interface Now Playing or Alarm Web interface pages. There will be no closure at a rear-panel GPO terminal,

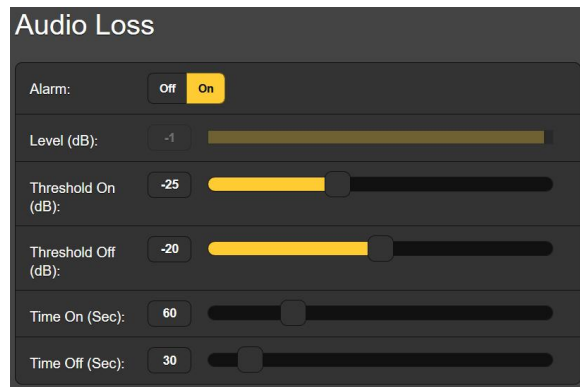

nor will the SOFIA 568 send SMS/text or Email alerts to station personnel or log the alarm. This applies to all alarms.

Level (dB): displays the audio metering level of the off-air program being received. This is 'grayed-out' because there is no adjustment in this case; the audio level is shown to make alarm setup decisions easier.

Threshold On (dB): is the set point that the program must drop below to trigger an alarm. Moreover, the program level must remain below this set point for the number of seconds programmed by the Time On (Sec): slider.

For the alarm to reset, the program level must re-attain a specified Threshold Off (dB): value and remain above that point for the number of seconds set by the Time Off (Sec): slider.

In the example shown, the program must fall below -25dB for a full 60 seconds to trigger an alarm. Then when the program returns, it must stay above -20dB for 30 seconds for the alarm to reset.

**Low Signal**

This alarm is similar to the one just discussed for audio loss. When Mute: is turned On, program audio at all outputs is ‘squelched’ (silenced) during the alarm interval. When receiving analog FM, this keeps ‘interstation hiss’ from making a nuisance of itself or, for HD Radio programs, ensures that audio is not heard as an intermittent staccato as it comes and goes with signal strength at the hairy edge of HD Radio decoding.

The RSSI (dBuV): grayed-out bargraph gives the level of the incoming RF carrier. Threshold On (dBuV): and Threshold Off (dBuV): set points are programmed in much the same manner as the audio-loss alarm example above.

**RDS Alarm**

There are two Off / On settings for RDS errors. Turning RDS Loss: On delivers an alarm when the RDS subcarrier simply goes missing. Setting PI Error: On gives an alarm when RDS is received with a PI code mismatch.

RDS data transmitted with an analog-FM broadcast contains a PI code unique to that station. A PI mismatch can signal a translator ‘hijacking’ by a radio hooligan, or the less sinister condition of the expected signal going off-air and a distant on-channel broadcast received in its place.

To enable the PI mismatch function, enter the station’s true PI code in the PI Code: box. The code being received at the moment is shown as Current PI:. Simply enter that hex value as shown and then click Save.

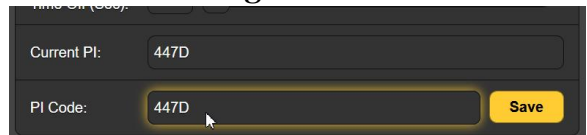

There are no threshold settings for RDS alarms, and both RDS loss and PI mismatch share the same Time On (Sec): and Time Off (Sec): settings, which work the same way as alarms already discussed.

**RT Update**

All too frequently a station’s playout system will ‘stick’ in sending RDS RadioText. RadioText is sent as a complete data message, unlike the static or scrolling PS field that is transmitted as a rapid succession of 8-character data blocks. This and other complexities (the associated RT+ features, for example) make the RadioText field more likely to cause problems than other RDS functions when it misses an update.

By turning the Alarm: for this function On, and setting a Time On (Min): at a nominal figure of 20 minutes or so, personnel will be alerted to a ‘stuck’ RadioText field.

<b>Pilot Loss</b>	This alarm indicates the loss of the FM stereo pilot, which could coincide with poor signal reception or a failure in the station's stereo generator. Although this is a rare transmitter plant failure item, it might signal a more general problem with the FM program when you are monitoring an HD Radio channel.
<b>HD Loss</b>	This function indicates loss of the HD Radio program that is selected and being monitored at the moment, or of the HD1 program when listening to analog FM. Although this alarm may seem somewhat redundant to loss of audio, for example, it may prove useful in catching intermittent exciter or HD exporter/importer issues. Other than what triggers it, this works just like the pilot loss alarm.
<b>HD PSD</b>	This alarm issues an alert when the HD Radio Program Service Data (PSD) is not updated in the expected timely manner.  Although there is a Time On (Min): setting common to all HD programs, each HD program may be selected to alarm when the Artist: the Title: or the Album: field(s) for the specified HD program does not receive an update in the Time On (Min): period. This feature is very similar to the RadioText Not Updated alarm for analog FM discussed above, except that it is a common alarm for all HD channels transmitted.
<b>HD Logo Alarm</b>	The SOFIA 568 can initiate an alarm when the station logo image is not received or updated in timely fashion. This alarm is otherwise similar to the HD PSD alarm, in that any or all of the HD channels may be selected to give an alarm, and the programmed Time On (Min): will hold common to all channels selected.
<b>HD Artist Experience</b>	This alarm parallels the HD Logo alarm just described, except that it relates to Artist Experience graphics instead of the station Logo tiles.
<b>HD Image Issues</b>	As explained on Page 20, built-in diagnostics alert the user to Logo and Artist Experience graphics that do not meet the HD Radio image specifications. When this Alarm: is turned On, you'll be notified of an image problem and the notation will be logged.  Clicking the <b>+</b> About Image Issues bar will display the helpful information with hyperlinks that was cited earlier.
<b>HD Emergency Alerts</b>	As of this writing, traffic, weather and other emergency messaging associated with the HD Radio system are being refined and put into practice. This alarm function gives a flashing front-panel alarm and sends email or SMS/Text messages concurrently with alerts, advising selected station personnel of the event, regardless of the type or seriousness of the alert sent.

## Alarm Logging

In addition to local displays and messaging alerts to signal and programming errors, alarm data are logged and stored indefinitely. You can click on **+ View Alarm Log** near the bottom of the page for a display of all alarms in chronological order.

The log holds data on the type of Alarm, which monitored Station it pertains to (important when the StationRotation feature is active), the Time and Date received, and its Duration.

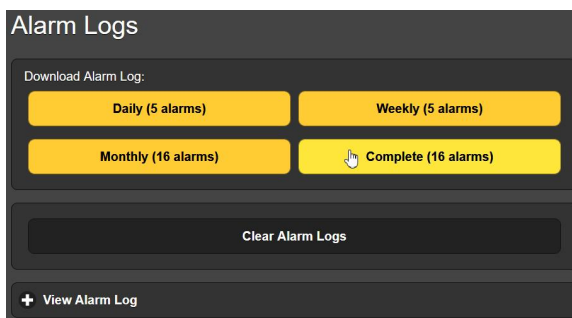

The screenshot shows the 'View Alarm Log' interface with a search bar and a table of alarm events. The table has columns for Alarm, Station, Time, Date, and Duration.

Alarm	Station	Time	Date	Duration
Audio back	94.7 HD1	12:47:06 PM	05/13/19	00:04:38
PI normal	94.7 HD1	12:46:31 PM	05/13/19	00:04:01
Audio loss	94.7 HD1	12:42:28 PM	05/13/19	
PI error	94.7 HD1	12:42:30 PM	05/13/19	
HD4 Artist not updated	94.7 HD1	10:12:27 AM	05/13/19	
PI error	94.7 HD1	02:38:28 PM	05/13/19	

You can View Alarm Log on your screen and even filter the results by overtyping Filter alarms... with a search term from the appropriate column.

You may also download the Alarm Logs for Daily, Weekly, Monthly or Complete (all alarms) time periods. The number of alarms received for these time periods is also shown here. Downloads are saved to your computer as small .csv text files.

The Alarm Log will continue to accumulate entries indefinitely. Clear it completely at any time by clicking the Clear Alarm Logs bar. This will delete all entries. You'll be asked to confirm this action, and you might decide to download the Complete log of all alarms first to be on the safe side.

## SETUP

This Web interface page is not as imposing as its name suggests, as SOFIA 568 setup is accomplished by entries on a number of the Web interface pages. The specific items on the Setup page are discussed in order here.

### Radio Settings

U.S. and Canadian stations broadcasting HD Radio (the majority of SOFIA 568 users) utilize 75-microsecond complementary pre- and de-emphasis in FM broadcasting. Thus 75 $\mu$ s is the default De-Emphasis: setting. This may be manually changed here to 50 $\mu$ s, the standard for Europe and some other regions outside North America, or to None as might be required for test purposes. A proper setting is recommended, as the wrong one will distort the tonal balance of FM reception.

Stereo is the obvious default setting of the Stereo/Mono: selector, although there may be justification for a Blend or even a

Mono setting to reduce annoying noise for reception of FM broadcasts under low-signal or multipath conditions. The Blend function automatically narrows the stereo image as the incoming RF signal degrades.

RDS/RBDS: sets the mode for RadioData between the North American RBDS or the European RDS standards. Although the two standards have become more-or-less 'harmonized' over the years, certain RDS features do still differ and will not behave appropriately with the wrong setting here. Again the default setting is for North America.

#### **Audio Outputs**

The levels for SOFIA 568 audio outputs are individually adjustable. Please note the associated comments relating to what these levels actually mean.

The Analog Level (dBu): slider sets the rear-panel XLR balanced left and right analog outputs to any dBu value between -15dBu and +15dBu. dBu signifies the *unloaded*, balanced level from these outputs, which have a source impedance of 200 ohms. This means that a 600-ohm *loaded* dBm reading will be about 2.5dB lower than the figure shown. However, the concept of 600-ohm sources and terminations in professional audio practices date back to the days of transformer coupling, leased telephone lines and 'repeat coils,' and the notion of impedance matching is nowadays generally disregarded.

Also with regard to the analog output level, the dBu notations beside the slider actually refer to the *r.m.s. average* level of a sine-wave tone with a peak value corresponding to 100% FM carrier modulation ( $\pm 75\text{kHz}$  monaural carrier deviation at 400Hz), or nominal 'full' HD Radio modulation.

The Digital Level (dBFS): slider adjusts the rear-panel XLR AES3 digital program line output between -30dBFS and 0dBFS. Levels in this case are dBFS *peak* values at the output, again corresponding to  $\pm 75\text{kHz}$  mono-FM carrier deviation, or 'full' HD Radio modulation. An accepted and appropriate setting for this slider would be in the neighborhood of -12dBFS, allowing sufficient headroom for FM carrier overmodulation, acknowledging that the average off-air program level will usually be so uncomfortably close to the peak level as not to demand a more conservative headroom buffer.

In general, the Dante/AoIP Level (dBFS): requires the same considerations as the AES digital output and may be set similarly.

#### **Streaming Outputs**

The Stream audio output references the Web-listening utility, which is independent of the Dante-based AoIP streaming. Web-listening relates to the little loudspeaker icon at the top of each SOFIA 568 Web interface page, which can be clicked-on by as many as 10 users at the same time who have Internet access to the unit. Also note that you can enter the IP address of the unit in the address bar of any browser, as described on Page 16.



The streaming Format: defaults to the popular MP3 standard, although it may be reset to OGG, a family of audio file types that may enjoy a slight sonic advantage over MP3, in addition to being license-free.

The streaming Bitrate: defaults to 128kbps, generally judged as acceptable for all-but-critical radio listening. For unbelievably-poor network conditions the bitrate can be reduced all the way down to 32kbps, or for high-quality audio over a local LAN, up to 256kbps.

The stream Sample Rate: may also be changed, from the radio broadcast-plant default of 44100Hz, to other sampling rates between 16kHz and 48kHz. Again, network limitations or specific installations may dictate the setting.

The SOFIA 568 offers both an HTTP/Icecast Stream for general ‘tune-in’ (listener request) listening, and an independent UDP Stream that allows the 568 to send raw compressed audio to a specific IP address and port. Both modes are available concurrently.

For the general-listening HTTP/Icecast Stream a unique and useful feature of the SOFIA 568 is the ability to add-in a fixed Audio Latency (Sec): delay that may help overcome deficiencies of an uncertain network connection. Rather than allowing network latency to degrade packet transmission, building-in an intentional delay of a few seconds gives the system time to reassemble the data with fewer errors with just a few seconds’ temporal inconvenience.

Although the SOFIA 568 can accommodate as many as 10 simultaneous HTTP/Icecast Stream Web listeners, the number of listeners can be truncated in the interest of better streaming service to fewer authorized listeners. The Max Listeners: slider can be set between 0 and 10.

For the SOFIA 568 to automatically start a UDP Stream feed to remote equipment upon startup, the IP Address: and Port: information must be entered where indicated. Of course the Enable must also be set to On.

Once changed, Stream settings must be saved by clicking on the Save bar. Note that this does reset the utility, disconnecting any current Web listeners, who then must log back on.

**General Purpose Outputs**

The rear-panel GPOs serve as ‘tally’ outputs for SOFIA 568 alarms. They give access to closures (or opens) to ground for any four alarms selected from the field of 12.

Each GPO is programmed separately. The Output # numbers on this Web interface page correspond to the four numbered terminals on the back of

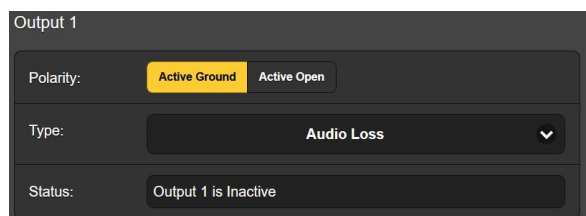

the unit. Current-limited +5V and ground are also provided on the terminal strip.

In the example, Output 1 has been Polarity:-programmed to deliver an Active Ground to GPO terminal 1 for an alarm Type: of Audio Loss. It could as easily have been set to deliver ground on that terminal all the time, and then go Active Open (ungrounded) when the alarm is received.

The Status: line in this example shows that Output 1 is Inactive; that is, the assigned Audio Loss alarm has not been tripped.

Any of the 12 alarm conditions could have been assigned here in the Type: field. Choose the four that are most important to you and assign them to the four GPOs.

## NETWORK SETUP AND INTERNET ACCESS

Obviously, if Web interface pages are appearing on your screen, what follows must already have been addressed. Getting up-and-running through front-panel setup was covered on Page 15, so most information here may turn out to be redundant.

### IP Setup

With Mode: set to DHCP, your router automatically assigns the SOFIA 568 an IP Address: and will populate the four associated fields, although they will be 'grayed-out' and you'll not be able to edit the data in those fields. However, if Mode: is changed to Static IP, then you must make the appropriate entries in all four fields.

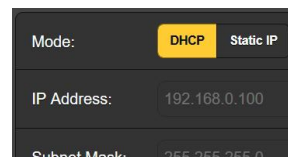

### Assigning a Hostname

You may change the default name SOFIA568 to something else, either to personalize the equipment name or to differentiate one SiteStreamer+ from another on the same network.

Overtyping the default Hostname: using all-capital letters and without using spaces. Be sure to click the Save bar at the bottom once all entries are finalized.

### HTTP Port

The default HTTP Port: 80 is commonly used when accessing networked equipment like the SOFIA 568 on a local network (LAN). Provision is included to change this to another number, as may be required under certain circumstances. Remember to Save your new setting.

### MAC Address

The MAC Address: (Machine Access Code) for your particular SOFIA 568 is factory-assigned and cannot be changed. You may wish to make note of your unit's 'signature,' however, to help identify it on your network.

### Link Speed

Link Speed: is simply an indication of connection status and the expected bitrate between your SOFIA 568 and the local network (LAN).

## Addressing the SOFIA 568

Under the Windows operating system, to access the SOFIA 568 Web interface on a common LAN simply type its Hostname and a forward-slash into the browser address bar as shown here. This entry is not case-sensitive. Non-Windows browsers may require you to enter the complete IP address of the unit, which you can always find by front-panel navigation to Setup / Network / IP Settings.

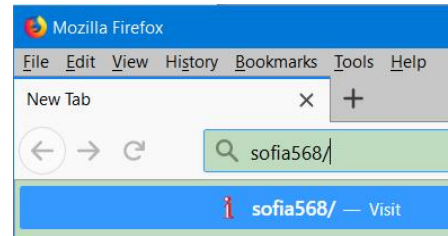

## Incoming Internet Access

To 'dial into' the SOFIA 568 from the Internet, the unit must be assigned a static IP address. If your router makes DHCP assignments for other equipment on the network, simply assign a static IP that is outside the router's DHCP range. This should be an easy matter with the aid of the router's Help utility.

You also need to open a specific port for the SOFIA 568 on the network router. Within the router's Port Forwarding utility you will be able to enter your static IP address for the unit (Internal IP), followed by a colon and a port number. The port number may be any number in the router's range.

If your Internet Service Provider (ISP) assigns you a static IP address, then it is a simple matter to address the SOFIA 568 from anywhere. Just type the IP address and port number into your browser as pictured here.

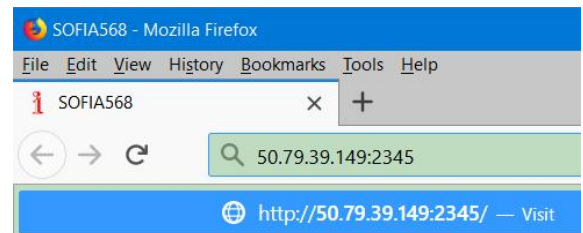

But if your ISP issues a *dynamic* IP, which is often the case, this mandates 'Dynamic DNS' operation, using the services of an IP-forwarding provider. This is an operation you should entrust to your IT department; explanations and instructions are available from multiple Web resources.

## DANTE<sup>®</sup> AND AoIP STREAMING

The term Dante<sup>®</sup> refers to networking technology developed by the Australian firm, Audinate Pty. Ltd. It enables simple connection with other Dante-equipped devices, and gives AES67 AoIP (Audio over Internet Protocol) compliance and interoperability among a wide range of pro-AV products. It is generally also compatible with proprietary systems from independent manufacturers of AoIP-enabled products.

## IP Settings Mode

The Dante-based AoIP utility of the SOFIA 568 is quite similar to the product's general networking function. Like the LAN connection, the independent AoIP connection may accept IP address assignments in either a DHCP or Static IP assignment

Mode: Static IP operation requires manual entries into the four fields that are grayed-out when your router makes DHCP assignments.

**AES67 and AoIP Streaming**

The Dante utility of the SOFIA 568 is able to AoIP-stream audio at two sample rates. The “AES67 Standard” from the Audio Engineering Society specifies a 48kHz sample rate, but Dante encoding can send at a 44.1kHz rate as well, a rate with wide use in radio and television broadcasting. With AES67 Enable: set to Enabled, streaming is forced to a 48kHz sample rate.

**The AoIP MAC Address**

The MAC address: for AoIP streaming is not the same as the one for general Web interactivity of the SOFIA 568. These are two independent network connections, and like the rear-panel LAN Port, the AoIP Port has a unique Mac Address: that is factory-assigned and cannot be changed.

**Link Speed**

Link Speed: this is a readout showing connection status and the expected networking rate for the AoIP connection.

**Audio Format**

Encoding: refers to the word length for the PCM-encoded digital audio to be sent as AoIP. 16 / 24 / 32 refers to word length for Dante AoIP flows; AES67 flows are locked to 24 bits regardless of this setting.

Sample Rate (Dante & AES3): is forced to 48kHz for AES67 streaming, or can be reset to 44.1kHz for other applications.

**Transmit Flows**

The AoIP utility can specify either one or two IP destinations for the audio stream. These are set in the Dante Controller.

This snapshot is typical of what you might see in the Transmit Flows area.

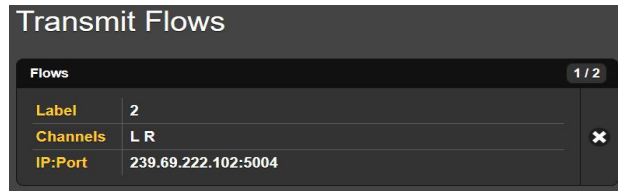

**The Dante Controller**

The Dante Controller is a free software utility available from Audinate, Dante’s developer. It is an essential software means of finding, setting-up and controlling Dante-enabled devices on your network. It may be downloaded for operation under either Windows or Macintosh operating systems from the following link.

<https://www.audinate.com/products/software/dante-controller>

## SNMP OPERATION

**Overview**

SNMP (Simple Network Management Protocol) allows other TCP/UDP/IP equipment on the same Local Area Network (LAN) to communicate directly with your SOFIA 568, and for your unit to send alarms and supplementary information to other equipment on the network.

The SOFIA 568 will interface directly with a network controller, technically known as the SNMP 'Manager.' The SOFIA 568 has an embedded ASCII text file called a Management Information Base, or MIB. In setting up for SNMP operation, the MIB file will have to be downloaded from your unit through the Web interface and uploaded to the SNMP Manager. This is detailed later on.

**Mode** The SNMP submenu default Mode: setting is Disabled, which inhibits communication between the SOFIA 568 and the SNMP Manager.

Changing Mode: to Read Only allows the SOFIA 568 to be interrogated by the SNMP Manager, so that programmed setup parameters, alarms, etc. can be integrated with other equipment on the network.

Setting the Mode: to Read & Write allows the SNMP Manager to send commands to your unit.

**Security** SNMP 'Communities' serve as passwords for this function. In the Read Community: and Write Community: fields, overtype the factory defaults and enter text that is specified for the read/write strings on the SNMP Manager monitoring device. You must do a Save after entering your text.

**Ports** The default SNMP Ports, SNMP Port: 161 and Trap Port: 162, are customary for a majority of SNMP operations. Overtyping these defaults to change them.

**Trap Destinations** When the SOFIA 568 *initiates* an alarm, rather than being *queried* or *polled* for one, the alarm is known as a 'trap.' Three local network IP addresses may be entered in the Trap Destination 1:, 2:, and 3: fields, each corresponding to other devices on the LAN that need to be apprised of alarms. Overtyping the defaults with valid IP addresses of other equipment.

**The MIB File** The MIB File is a small text file required by the SNMP Manager. Click: Download MIB to save this file using the usual Windows methods. The MIB file is in plain text with a .mib extension, and may be read with Windows Notepad.

NOTE: This is an abbreviated discussion of SNMP operation. SNMP is a complex utility, managed exclusively by whatever SNMP 'Manager' (monitoring equipment) is employed. Refer to all instructions supplied with, and for, the SNMP Manager hardware and/or software in setting-up the SOFIA 568.

## EMAIL

**Email and Text Notifications** NOTE: The time-stamp feature for email notifications and the Alarm Log depends on a network connection to sync with Internet time, along with setting the proper time zone and other options. This is detailed on Page 37.

Connected to the Internet, the SOFIA 568 can send email or SMS/text notifications of reception or programming errors to one or more recipients. Which alarms go to whom is a separate setup routine.

**SMTP Setup**

The SOFIA 568 must first be properly programmed to send mail under SMTP Settings. You need to set up an actual email account, the elements of which are just like setting up any conventional email account. Information to be entered here depends on the provider you choose. When you apply for the account, much of this information will be assigned to you. Consult your IT professional for setting up email accounts if you need to.

Under SMTP Server:, enter the provided outgoing mail server info (e.g.: smtp.gmail.com), the required Port: number and whether TLS: is On or Off.

From: is the 'friendly' name that identifies the SOFIA 568 to the email or SMS/text recipient. You could use station call letters, or something like SOFIA Alarm or Uh-Oh. User: is the full email address of the unit. You may assign a Password: to the account.

**Recipients,  
(Send To)**

Next enter up to ten email recipients, typing-in the full email address. After this you'll decide who gets what alert.

Email addresses typically take the form of the upper example here. If instead you wish to send a text message to a recipient's cell phone, the entry may look like the second image. In this instance the alarm notifications are being directed to a Verizon subscriber's phone. Further information on these naming protocols is available on the Web, or you can check with the wireless carrier to confirm the proper addressing style for Internet texting delivery.

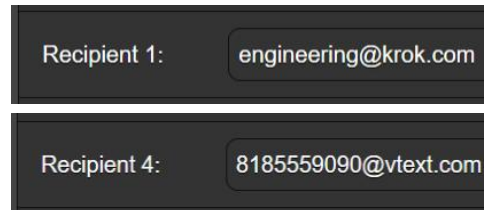

When all recipients have been entered, click Save. You may also click Send Test Email, which will message all recipients to confirm proper communications setup.

**Notifications,  
(Send What)**

You can assign any or all alarms to any or all email or text addresses in the Notifications section.

Referring to the example here, choose a recipient 1 through 10 by clicking the down arrow. With a Recipient: selected, click the Send Emails For: boxes to choose which alarm conditions will be reported to that individual.

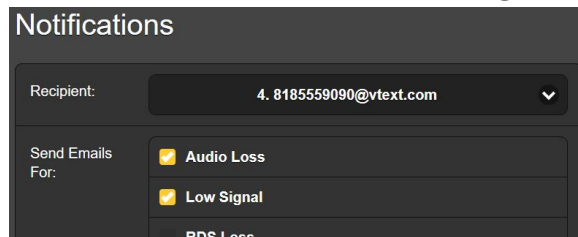

In this abbreviated example, the Chief Engineer will receive a text message on his phone for Audio Loss and Low Signal alarms.

When you've finished with this Recipient, proceed to the next. No Save command is necessary in this operation.

## TIME SETUP

### Time and DST

The onboard Real Time Clock updates from Internet Time daily and has sufficient inherent precision to remain accurate inside this schedule. Grab and drag the Time Zone (Hours): slider for the proper offset from Universal Coordinated Time for your area. In this example, the -8 represents West Coast US (Pacific) time. The time at the top of the page will update immediately, so you can simply drag the slider until the time shown here agrees with the big clock on the wall.

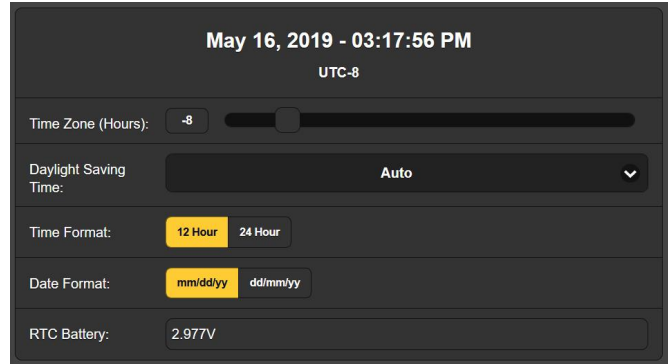

Daylight Saving Time: is set to the default Auto mode in this example. You may either opt for this convenience, or click the down arrow to select On or Off for DST.

### Presentation Formats

Time Format: can show either a 12 Hour or a 24 Hour clock, and the Date Format: can reflect either US or European conventions. The date is automatically set by the Internet Time Server.

### RTC Battery

The Real Time Clock has a backup battery located on the rear of the front-panel board. This is a 3V CR2032 flat 'coincell' battery with the + side facing out. Replace the battery when RTC Battery: voltage drops to 2V.

### Time Server

We have provided a reliable default time server, which is 1.inovonics.pool.ntp.org. If you must change the server because of some corporate edict, overtype the Server: entry with your alternate and click Save.

## ADMINISTRATIVE MATTERS

### Security and Passwords

SOFIA 568 access may be protected by multilevel passwords, which must then be entered before screens can be seen or entries changed.

#### NOTE:

All passwords *will appear in clear text* on the Admin OLED menu screen.

All passwords *are hidden* on the Admin Web interface page when logged-in as a 'Web User (Read Only).'

Under the Web interface Security heading, type-in the Front Panel: password, which then must be manually entered with the front-panel knob when accessing the unit at the equipment site.

There are two Web interface passwords. Web Admin Password (Read/Write): is the Administrator password that allows full access to the SOFIA 568. Web User Password (Read Only): allows the lower-level user to view all data, but those users cannot tune the radio or make changes to any settings. Once passwords have been assigned, click Save to lock them into nonvolatile memory.

Once passwords have been entered and saved, the front-panel Now Playing screen will be the only one visible, and all Web interface screens will be locked out.

With respect to front-panel access, the SOFIA 568 will lock any time the screen times-out (goes dim or dark) after the unit is untouched for the programmed timeout period. It may be locked immediately by holding down the Back button for a few seconds.

### Signing In

With password protection in place, at the installation site you will be prompted to enter the password through the front-panel OLED screen and jog knob before any menu can be accessed other than Now Playing. Use the jog knob to spell-out the password, and then highlight Save and push the knob. This will be necessary each time the unit times out to a dark or dim screen.

When working on a protected unit over an extended period, you can avoid the frustration of having to keep re-entering a password from the front panel by resetting the Admin / Display / Timeout setting to 60 min. From the Admin / Security screen you could also repeatedly push Del to delete the password, but jot it down first, of course, so you can put it back in when finished.

The Web interface password must be entered on any connecting device. When this image appears on your screen, ignore User Name: and enter either the Web Admin or the Web User password into the Password: field, then click OK.

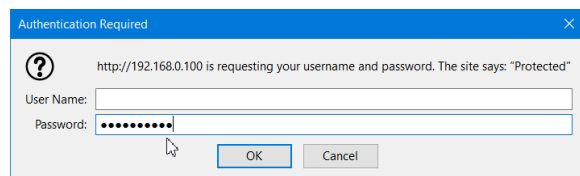

### Lost Password (Hard Reset)

**NOTE:** A 'hard reset' is required to bypass a local or a Web interface password. *This must be done at the installation site!* A hard reset not only deletes the password, but will also return the SOFIA 568 to all-factory-default settings. *All User settings will be lost!* This illustrates the importance of keeping a Hardware Profile current, which is discussed next.

If the password is lost, the only way you can recover control of the SOFIA 568 is from the equipment site. Hold down the Back button as you power-cycle the unit (disconnect and then reconnect AC-mains power).



## The Hardware Profile

The entire SOFIA 568 ‘setup’ may be saved to your computer as a small text file. The Hardware Profile includes user settings, alarm notification preferences, SNMP options, etc., and is useful for restoring a previous setup or for cloning a second unit for backup service.

To save a profile to your computer, under Configuration click: Download Hardware Profile. With the Firefox browser used in this example, Windows first asks whether to Open or Save the file. After clicking the Save button and OK, Windows saves the file to the Windows Downloads folder.

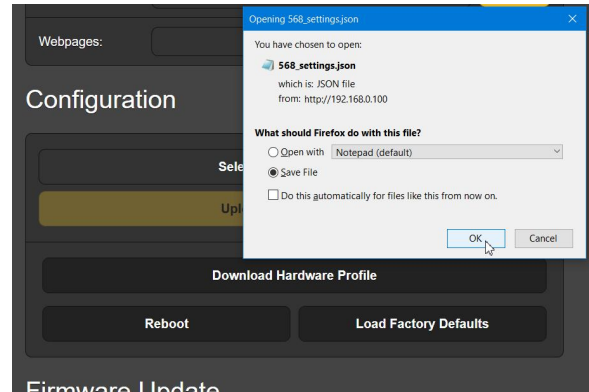

From there you can move it to a location of your choice. Other browsers may ask you directly to specify a Save as: location. The file carries a default name of 568\_settings.json.

To upload (restore) a saved setting, first click Select Hardware Profile..., navigate to where you have saved the profile, and when prompted, Open the file. Then click Upload Hardware Profile. This will replace all set-up parameters currently loaded and running in your SOFIA 568 with the saved ones.

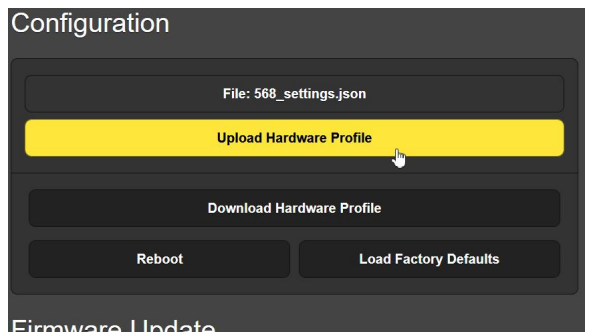

## Reboot

Uploading a Hardware Profile *automatically* reboots the SOFIA 568. There may be other circumstances under which you might want to reboot the unit manually. This can be done by clicking Reboot in the Configuration area.

A *manual* reboot does not change any settings or dump any accumulated off-air data, it's simply the same as doing a local power cycle. The SOFIA 568 will come back tuned to the same station and with all settings intact.

However, at any time you wish to ‘clean house’ and restore all settings and preferences to factory values, click: Load Factory Defaults. In this case you *will* lose your settings, except for IP settings (to maintain access to the unit), so doing a Hardware Profile download first might be a good idea.

## Updating Firmware

SOFIA 568 firmware includes the Web interface pages, and updates are easily uploaded to the unit when issued by Inovonics.

NOTE: We recommend saving a fresh Hardware Profile, as a firmware update may affect user settings. If there is danger of

compromising stored data, the firmware update will include notes to that effect.

Updates are issued as small .bin files which may be downloaded to your computer Desktop or placed in any convenient folder. From the Firmware Update utility at the bottom of the Admin screen, click **Select Firmware File...** and double-click the .bin file listing. This will transfer the file to the updater as shown below.

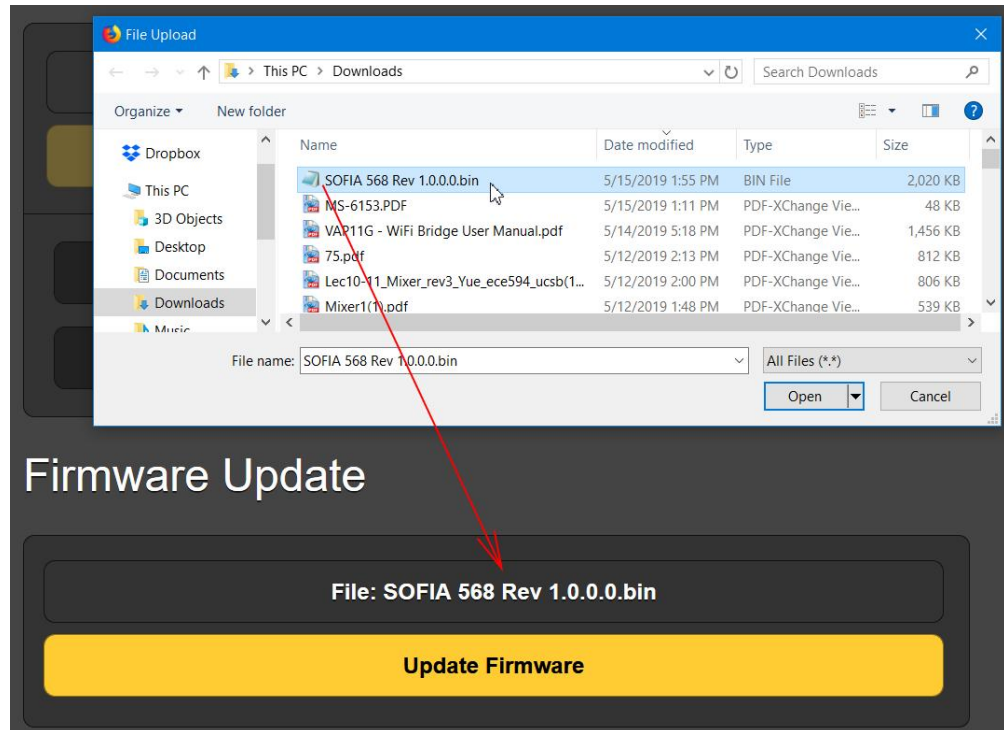

With the name of the new .bin showing in File:, Click **Update Firmware** and follow prompts to complete the process. Updating takes a couple of minutes and will return you to the new Web interface pages once the operation is complete.

#### **'About' Info**

The bottom of the Admin screen shows the **Serial Number:** of your SOFIA 568 SiteStreamer+, gives the current **Firmware Rev:** and displays the **Uptime:**, or how long your SOFIA 568 has been running since power was last applied. You also may click **Check for Updates** to see if a new version of the firmware has been issued.



# INOVONICS WARRANTY

- I TERMS OF SALE:** Inovonics products are sold with an understanding of “full satisfaction”; that is, full credit or refund will be issued for products sold as new if returned to the point of purchase within 30 days following their receipt, provided that they are returned complete and in an “as received” condition.
- II CONDITIONS OF WARRANTY:** The following terms apply unless amended *in writing* by Inovonics, Inc.
- A. Register the Warranty online at [www.inovonicsbroadcast.com](http://www.inovonicsbroadcast.com) within 10 days of delivery.
  - B. This Warranty applies only to products sold “as new.” It is extended only to the original end-user and may not be transferred or assigned without prior written approval by Inovonics.
  - C. This Warranty does not apply to damage caused by misuse, abuse, accident or neglect. This Warranty is voided by unauthorized attempts at repair or modification, or if the serial identification label has been removed or altered.
- III TERMS OF WARRANTY:** Inovonics, Inc. products are warranted to be free from defects in materials and workmanship.
- A. Any discrepancies noted within THREE YEARS of the date of delivery will be repaired free of charge, or will be replaced with a new or remanufactured product at Inovonics’ option.
  - B. Parts and labor for factory repair required after the three-year Warranty period will be billed at prevailing prices and rates.
- IV RETURNING GOODS FOR FACTORY REPAIR:**
- A. Equipment will not be accepted for Warranty or other repair without a Return Authorization (RA) number issued by Inovonics prior to its return. An RA number may be obtained by calling the factory. The number should be prominently marked on the outside of the shipping carton.
  - B. Equipment must be shipped prepaid to Inovonics. Shipping charges will be reimbursed for valid Warranty claims. Damage sustained as a result of improper packing for return to the factory is not covered under terms of the Warranty and may occasion additional charges.

